

SNUBBERLESS TRIACS

FEATURES

- $I_{T(RMS)} = 25A$
- HIGH COMMUTATION :
 $(di/dt)_c \geq 12A/ms$ T2514xKS
 $\geq 22A/ms$ T2516xKS
- INSULATING VOLTAGE = 2500V_(RMS)
 (UL RECOGNIZED : E81734)

DESCRIPTION

The T2514/T2516xKS series of isolated triacs uses a high performances MESA GLASS technology.

The SNUBBERLESS™ concept offer suppression of RC network and it is suitable for application such as phase control and static switching on inductive or resistive load.

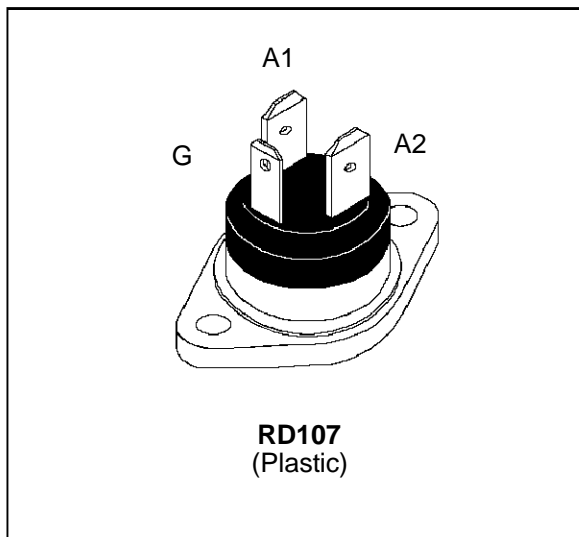

ABSOLUTE RATINGS (limiting values)

Symbol	Parameter		Value	Unit
$I_{T(RMS)}$	RMS on-state current (360° conduction angle)	$T_c = 85^\circ C$	25	A
I_{TSM}	Non repetitive surge peak on-state current (T_j initial = 25°C)	$t_p = 8.3ms$	260	A
		$t_p = 10ms$	250	
I^2t	I^2t vauke for fusing	$t_p = 10ms$	312	A ² s
di/dt	Critical rate of rise of on-state current $I_G = 500mA$ $dI_G/dt = 1A/\mu s$	Repetitive $F = 50Hz$	20	A/ μs
		Non repetitive	100	
T_{stg} T_j	Storage and operating junction temperature range		- 40 + 150 - 40 + 125	°C
TI	Maximum lead temperature for soldering during 10s		260	°C

Symbol	Parameter	Voltage				Unit
		D	M	S	N	
V_{DRM} V_{RRM}	Repetitive peak off-state voltage $T_j = 125^\circ C$	400	600	700	800	V

T2514xKS / T2516xKS

THERMAL RESISTANCES

Symbol	Parameter	Value	Unit
Rth(j-c)	Junction to case for D.C	1.7	°C/W
Rth(j-c)	Junction to case for A.C 360° conduction angle (F=50Hz)	1.3	°C/W

GATE CHARACTERISTICS (maximum values)

$P_{G(AV)} = 1\text{ W}$ $P_{GM} = 10\text{ W}$ ($t_p = 20\ \mu\text{s}$) $I_{GM} = 4\text{ A}$ ($t_p = 20\ \mu\text{s}$)

ELECTRICAL CHARACTERISTICS

Symbol	Test Conditions	Quadrant		Sensitivity		Unit	
				14	16		
I_{GT}	$V_D = 12\text{V (DC)}$ $R_L = 33\Omega$	$T_j = 25^\circ\text{C}$	I-II-III	MIN	2		mA
				MAX	35	50	
V_{GT}	$V_D = 12\text{V (DC)}$ $R_L = 33\Omega$	$T_j = 25^\circ\text{C}$	I-II-III	MAX	1.5		V
V_{GD}	$V_D = V_{DRM}$ $R_L = 3.3\text{k}\Omega$	$T_j = 125^\circ\text{C}$	I-II-III	MIN	0.2		V
tgt	$V_D = V_{DRM}$ $I_T = 35\text{A}$ $I_G = 500\text{mA}$ $di_G/dt = 3\text{A}/\mu\text{s}$	$T_j = 25^\circ\text{C}$	I-II-III	TYP	2		μs
I_H^*	$I_T = 250\text{mA}$ Gate open	$T_j = 25^\circ\text{C}$		MAX	35	50	mA
I_L	$I_G = 1.2 I_{GT}$	$T_j = 25^\circ\text{C}$	I-III	TYP	35	50	mA
			II	TYP	70	100	
V_{TM}^*	$I_{TM} = 35\text{A}$ $t_p = 380\mu\text{s}$	$T_j = 25^\circ\text{C}$		MAX	1.5		V
I_{DRM} I_{RRM}	$V_D = V_{DRM}$ $V_R = V_{RRM}$	$T_j = 25^\circ\text{C}$		MAX	10		μA
		$T_j = 125^\circ\text{C}$		MAX	3		mA
dV/dt *	$V_D = 67\%V_{DRM}$ Gate open	$T_j = 125^\circ\text{C}$		MIN	500	750	V/ μs
(di/dt)c *	Without snubber	$T_j = 125^\circ\text{C}$		MIN	12	22	A/ms
				TYP	24	44	

* For either polarity of electrode A₂ voltage with reference to electrode A₁

ORDERING INFORMATION

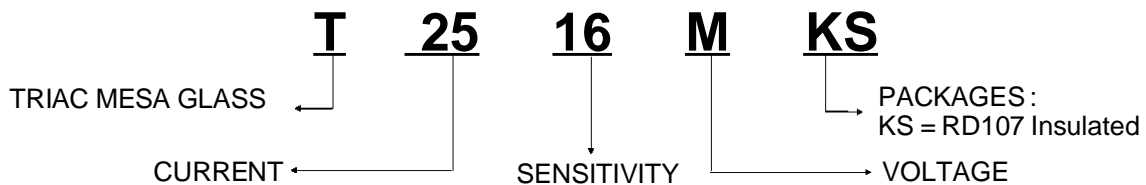

Fig.1 : Maximum RMS power dissipation versus average on-state current.

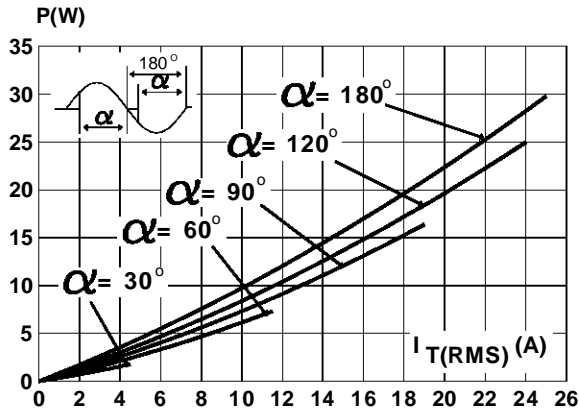

Fig.2 : Correlation between maximum RMS power dissipation and maximum allowable temperature (Tamb and Tcase) for different thermal resistances heatsink + contact).

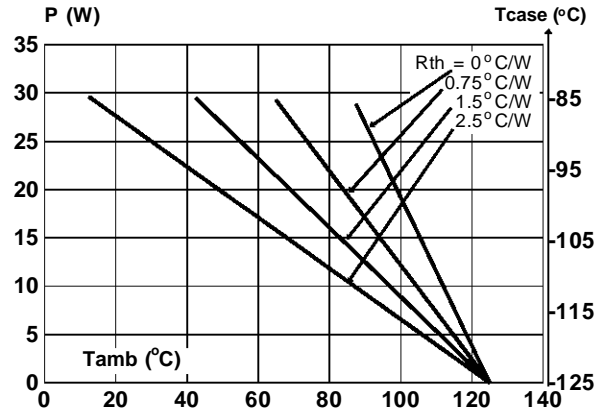

Fig.3 : RMS on-state current versus case temperature.

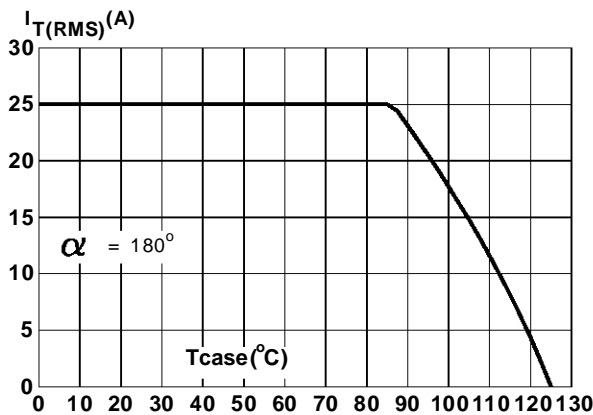

Fig.4 : Relative variation of thermal impedance junction to case versus pulse duration.

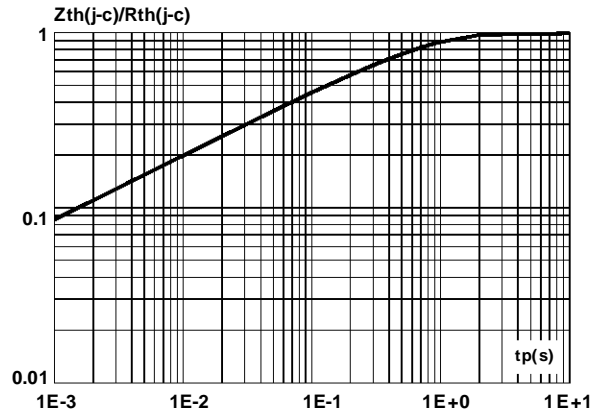

Fig.5 : Relative variation of gate trigger current and holding current versus junction temperature.

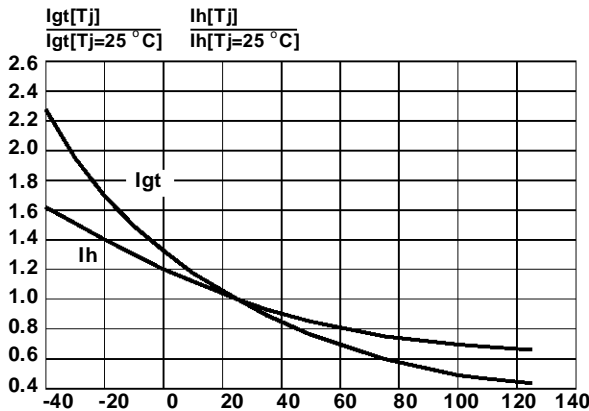
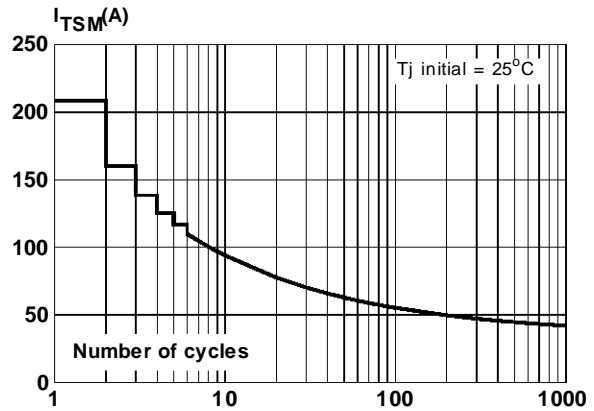

Fig.6 : Non repetitive surge peak on-state current versus number of cycles.



T2514xKS / T2516xKS

Fig.7 : Non repetitive surge peak on-state current for a sinusoidal pulse with width : $t_p \leq 10\text{ms}$, and corresponding value of I^2t .

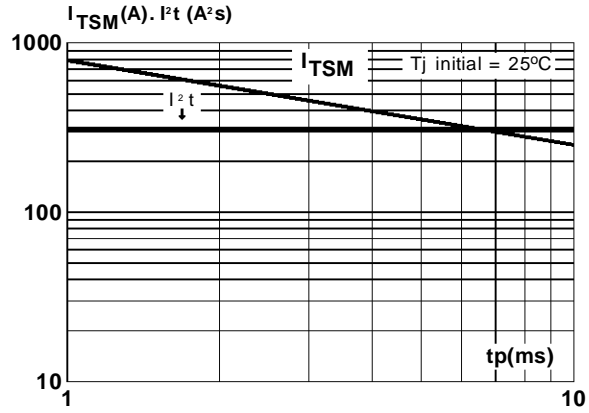
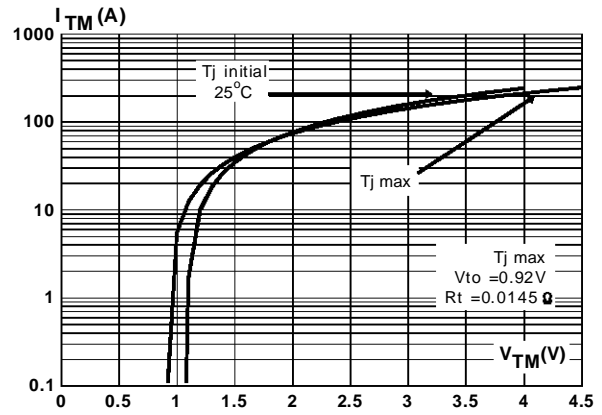
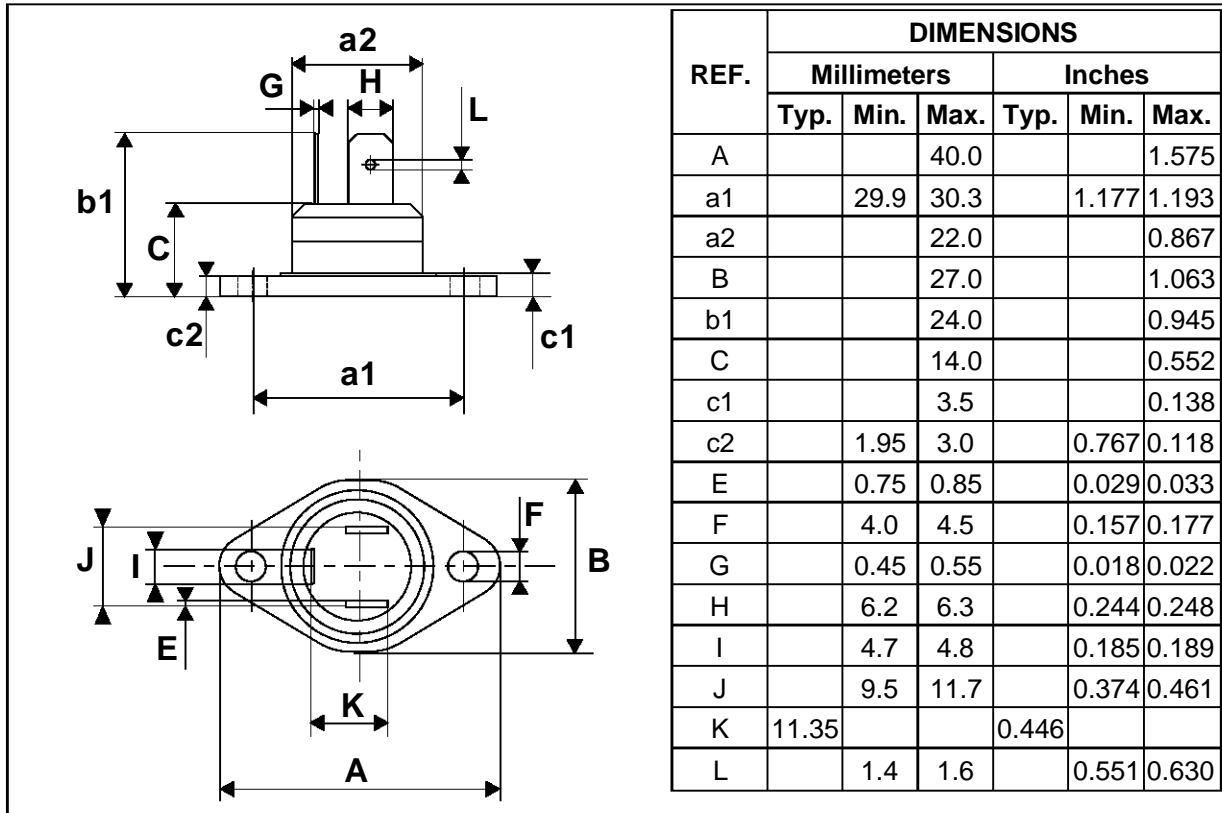

Fig.8 : On-state characteristics (maximum values).



PACKAGE MECHANICAL DATA
RD107 (Plastic)



Marking : type number
Weight : 20g

Information furnished is believed to be accurate and reliable. However, SGS-THOMSON Microelectronics assumes no responsibility for the consequences of use of such information nor for any infringement of patents or other rights of third parties which may result from its use. No license is granted by implication or otherwise under any patent or patent rights of SGS-THOMSON Microelectronics. Specifications mentioned in this publication are subject to change without notice. This publication supersedes and replaces all information previously supplied. SGS-THOMSON Microelectronics products are not authorized for use as critical components in life support devices or systems without express written approval of SGS-THOMSON Microelectronics.

© 1995 SGS-THOMSON Microelectronics - Printed in Italy - All rights reserved.

SGS-THOMSON Microelectronics GROUP OF COMPANIES

Australia - Brazil - France - Germany - Hong Kong - Italy - Japan - Korea - Malaysia - Malta - Morocco - The Netherlands
Singapore - Spain - Sweden - Switzerland - Taiwan - Thailand - United Kingdom - U.S.A.